

## Features

- Single N-Channel MOSFET
- Low On-Resistance
- Very Low Gate Threshold Voltage
- Low Input Capacitance
- Fast Switching Speed
- Low Input/Output Leakage
- Ultra-Small Surface Mount Package
- **Lead Free By Design/RoHS Compliant (Note 2)**
- **"Green" Device (Note 3)**



TOP VIEW

SOT-23

## Mechanical Data

- Case: SOT-23
- Case Material: Molded Plastic, "Green" Molding Compound. UL Flammability Classification Rating 94V-0
- Moisture Sensitivity: Level 1 per J-STD-020C
- Terminal Connections: See Diagram
- Terminals: Finish — Matte Tin annealed over Copper leadframe. Solderable per MIL-STD-202, Method 208
- Marking Information: See Page 4
- Ordering Information: See Page 4
- Weight: 0.008 grams (approximate)

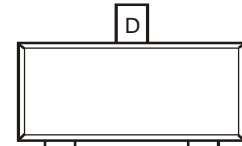
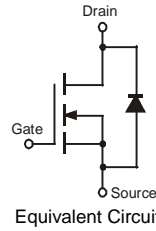

## Maximum Ratings @T<sub>A</sub> = 25°C unless otherwise specified

Characteristic	Symbol	Value	Units
Drain-Source Voltage	V <sub>DSS</sub>	50	V
Drain-Gate Voltage R <sub>GS</sub> ≤ 1.0MΩ	V <sub>DGR</sub>	50	V
Gate-Source Voltage	V <sub>GSS</sub>	±20 ±40	V
Drain Current (Note 1)	I <sub>D</sub>	280	mA
Drain Current (Note 1)	I <sub>DM</sub>	1.5	A

## Thermal Characteristics @T<sub>A</sub> = 25°C unless otherwise specified

Characteristic	Symbol	Value	Units
Total Power Dissipation (Note 1)	P <sub>d</sub>	350	mW
Thermal Resistance, Junction to Ambient (Note 1)	R <sub>θJA</sub>	357	°C/W
Operating and Storage Temperature Range	T <sub>j</sub> , T <sub>STG</sub>	-55 to +150	°C

## Electrical Characteristics @T<sub>A</sub> = 25°C unless otherwise specified

Characteristic	Symbol	Min	Typ	Max	Unit	Test Condition
<b>OFF CHARACTERISTICS (Note 4)</b>						
Drain-Source Breakdown Voltage	BV <sub>DSS</sub>	50	—	—	V	V <sub>GS</sub> = 0V, I <sub>D</sub> = 10μA
Zero Gate Voltage Drain Current	I <sub>DSS</sub>	—	—	0.1 500	μA	@ T <sub>C</sub> = 25°C @ T <sub>C</sub> = 125°C V <sub>DS</sub> = 50V, V <sub>GS</sub> = 0V
Gate-Body Leakage	I <sub>GSS</sub>	—	—	±20	nA	V <sub>GS</sub> = ±20V, V <sub>DS</sub> = 0V
<b>ON CHARACTERISTICS (Note 4)</b>						
Gate Threshold Voltage	V <sub>GS(th)</sub>	0.49	—	1.2	V	V <sub>DS</sub> = V <sub>GS</sub> , I <sub>D</sub> = 250μA
Static Drain-Source On-Resistance	R <sub>DS(ON)</sub>	—	1.6 2.2	3 4	Ω	V <sub>GS</sub> = 2.7V, I <sub>D</sub> = 0.2A, V <sub>GS</sub> = 1.8V, I <sub>D</sub> = 50mA
On-State Drain Current	I <sub>D(ON)</sub>	0.5	1.0	—	A	V <sub>GS</sub> = 10V, V <sub>DS</sub> = 7.5V
Forward Transconductance	g <sub>FS</sub>	200	—	—	mS	V <sub>DS</sub> = 10V, I <sub>D</sub> = 0.2A
Source-Drain Diode Forward Voltage	V <sub>SD</sub>	0.5	—	1.4	V	V <sub>GS</sub> = 0V, I <sub>S</sub> = 115mA
<b>DYNAMIC CHARACTERISTICS</b>						
Input Capacitance	C <sub>iss</sub>	—	—	50	pF	V <sub>DS</sub> = 25V, V <sub>GS</sub> = 0V f = 1.0MHz
Output Capacitance	C <sub>oss</sub>	—	—	25	pF	
Reverse Transfer Capacitance	C <sub>rss</sub>	—	—	5.0	pF	

- Notes:
1. Device mounted on FR-4 PCB, 1 inch x 0.85 inch x 0.062 inch; pad layout as shown on Diodes Inc. suggested pad layout document AP02001, which can be found on our website at <http://www.diodes.com/datasheets/ap02001.pdf>.
  2. No purposefully added lead.
  3. Diodes Inc.'s "Green" policy can be found on our website at [http://www.diodes.com/products/lead\\_free/index.php](http://www.diodes.com/products/lead_free/index.php)
  4. Short duration pulse test used to minimize self-heating effect.

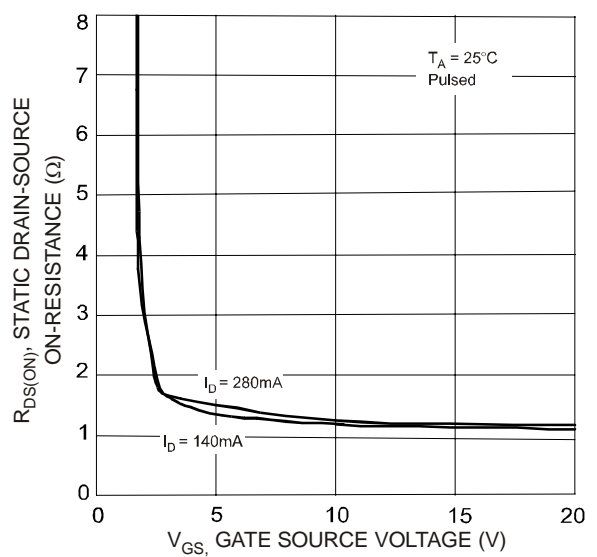
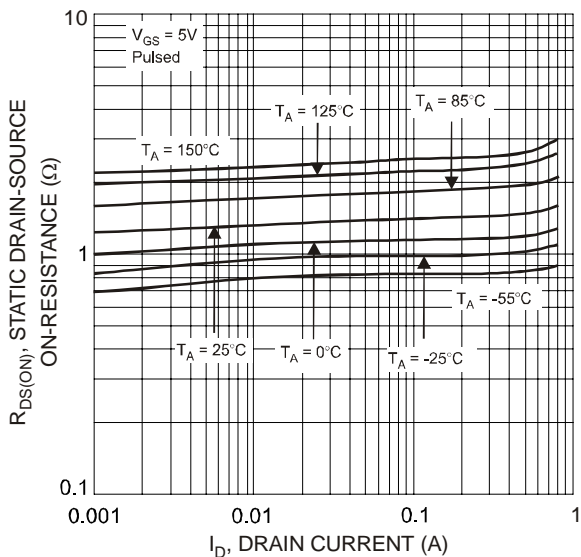
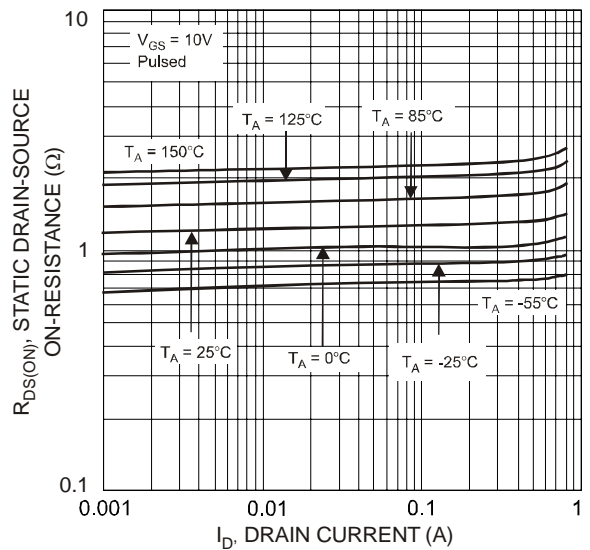
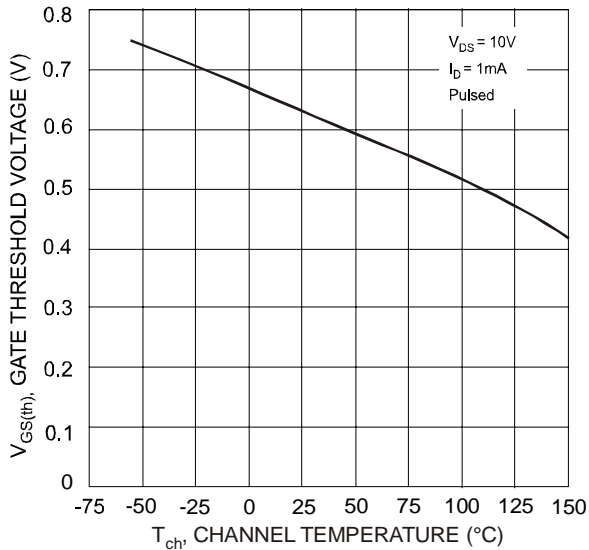
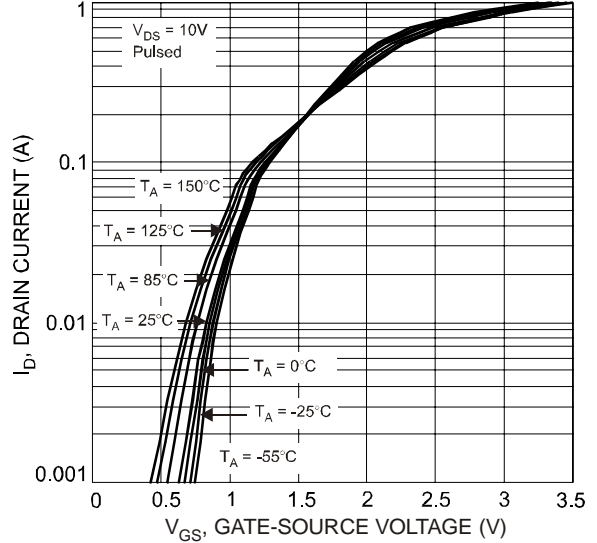
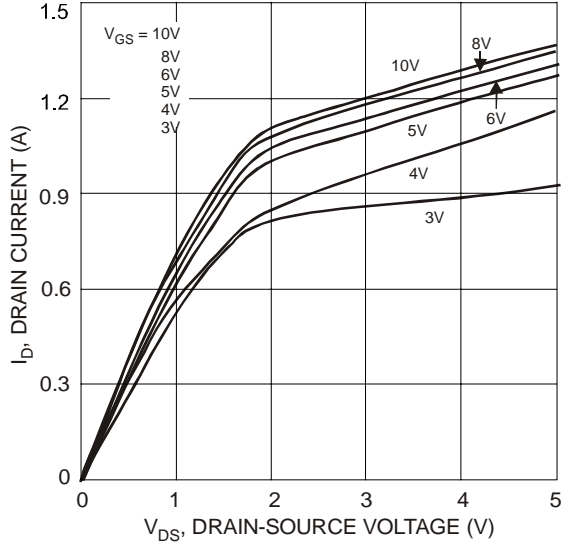

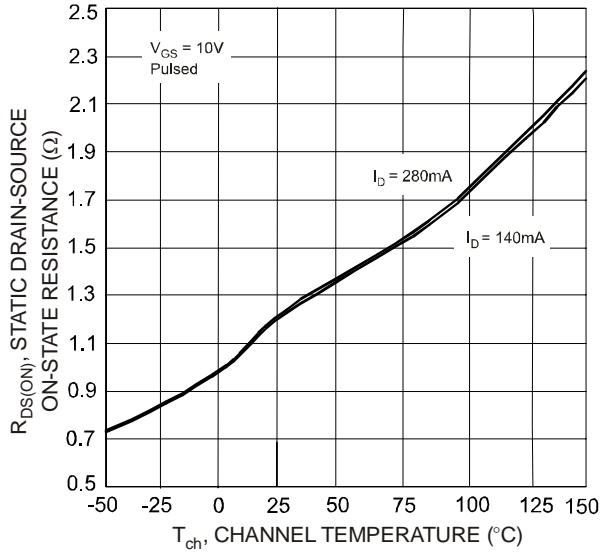

Fig. 7 Static Drain-Source On-State Resistance vs. Channel Temperature

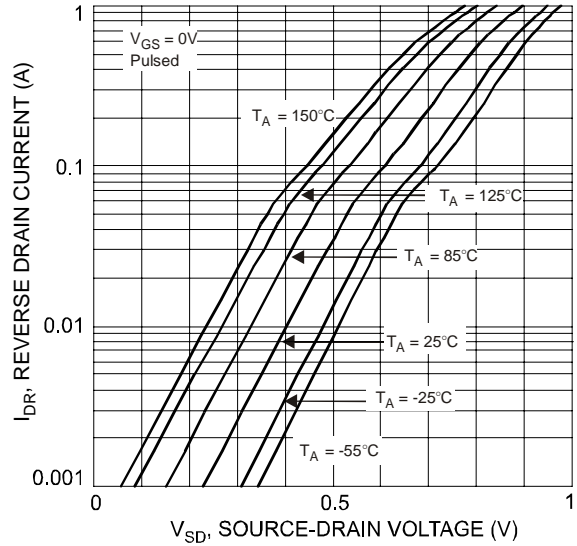

Fig. 8 Reverse Drain Current vs. Source-Drain Voltage

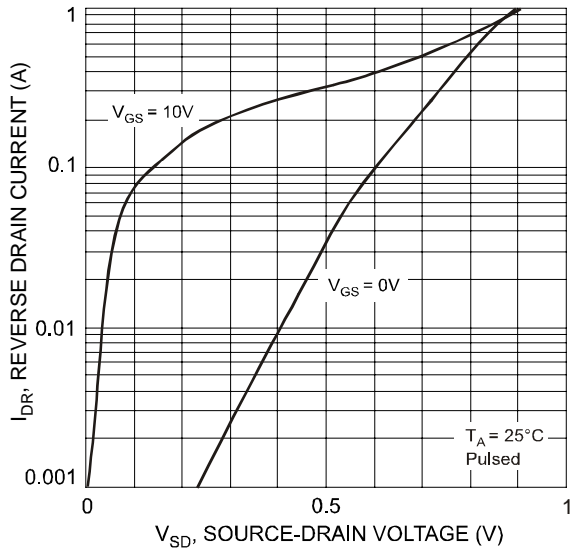

Fig. 9 Reverse Drain Current vs. Source-Drain Voltage

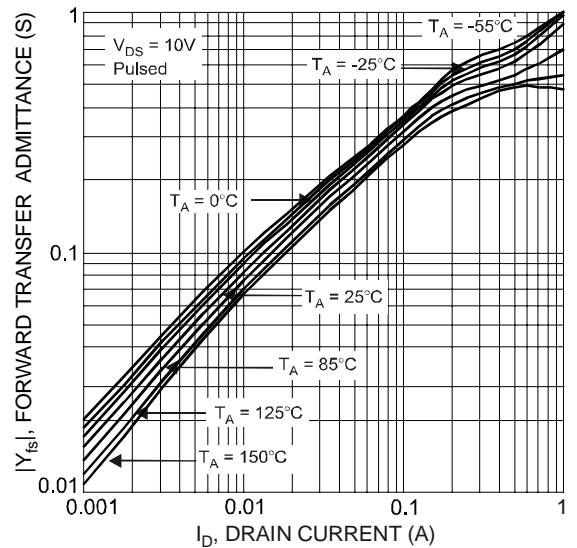

Fig. 10 Forward Transfer Admittance vs. Drain Current

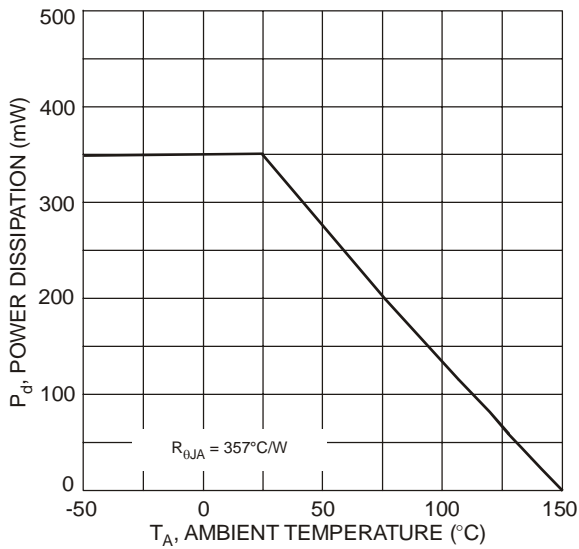

Fig. 11 Derating Curve - Total

**Ordering Information** (Note 5)

Part Number	Case	Packaging
DMN5L06-7	SOT-23	3000/Tape & Reel

Notes: 5. For packaging details, go to our website at <http://www.diodes.com/datasheets/ap02007.pdf>.

**Marking Information**

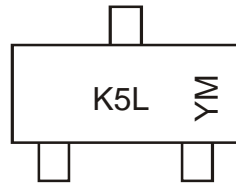

K5L = DMN5L06 Product Type Marking Code  
 YM = Date Code Marking  
 Y = Year ex: S = 2005  
 M = Month ex: 9 = September

Date Code Key

Year	2005	2006	2007	2008	2009	2010	2011	2012
Code	S	T	U	V	W	X	Y	Z

Month	Jan	Feb	Mar	Apr	May	Jun	Jul	Aug	Sep	Oct	Nov	Dec
Code	1	2	3	4	5	6	7	8	9	O	N	D

**Package Outline Dimensions**

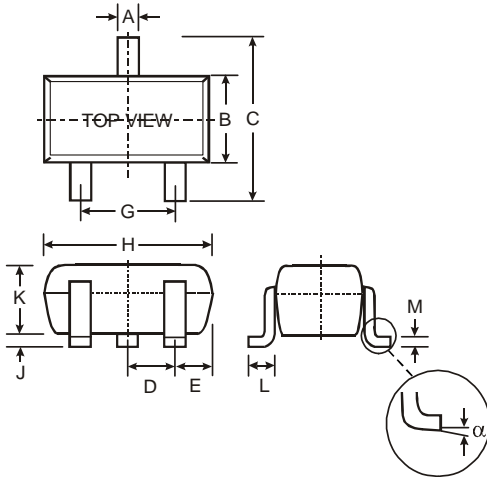

SOT-23		
Dim	Min	Max
A	0.37	0.51
B	1.20	1.40
C	2.30	2.50
D	0.89	1.03
E	0.45	0.60
G	1.78	2.05
H	2.80	3.00
J	0.013	0.10
K	0.903	1.10
L	0.45	0.61
M	0.085	0.180
$\alpha$	0°	8°
All Dimensions in mm		

**Suggested Pad Layout**

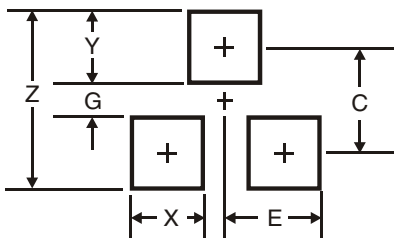

Dimensions	Value (in mm)
Z	3.4
G	0.7
X	0.9
Y	1.4
C	2.0
E	0.9

**IMPORTANT NOTICE**

Diodes Incorporated and its subsidiaries reserve the right to make modifications, enhancements, improvements, corrections or other changes without further notice to any product herein. Diodes Incorporated does not assume any liability arising out of the application or use of any product described herein; neither does it convey any license under its patent rights, nor the rights of others. The user of products in such applications shall assume all risks of such use and will agree to hold Diodes Incorporated and all the companies whose products are represented on our website, harmless against all damages.

**LIFE SUPPORT**

Diodes Incorporated products are not authorized for use as critical components in life support devices or systems without the expressed written approval of the President of Diodes Incorporated.