

**NOT RECOMMENDED FOR NEW DESIGNS
USE DFLZ SERIES**

Features

- 1.0W Power Dissipation
- Ideally Suited for Automatic Assembly
- 5.1V - 39V Nominal Zener Voltage Range
- Standard V_Z Tolerance is $\pm 5\%$
- **Lead Free Finish/RoHS Compliant (Note 2)**

Mechanical Data

- Case: SMA
- Case Material: Molded Plastic. UL Flammability Classification Rating 94V-0
- Moisture Sensitivity: Level 1 per J-STD-020C
- Terminals: Lead Free Plating (Matte Tin Finish). Solderable per MIL-STD-202, Method 208
- Marking: Marking & Date Code (See Page 2)
- Ordering Information: See Page 2
- Polarity: Cathode Notch or Cathode Band
- Weight: 0.064 grams (approximate)

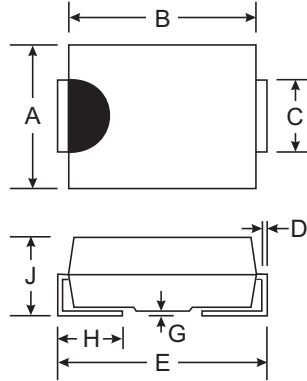

SMA		
Dim	Min	Max
A	2.29	2.92
B	4.00	4.60
C	1.27	1.63
D	0.15	0.31
E	4.80	5.59
G	0.10	0.20
H	0.76	1.52
J	2.01	2.62
All Dimensions in mm		

Maximum Ratings @ $T_A = 25^\circ\text{C}$ unless otherwise specified

Characteristic	Symbol	Value	Unit
Zener Current (see Table page 2)	I_{ZM}	P_d / V_Z	mA
Forward Voltage @ $I_F = 200\text{mA}$	V_F	1.2	V
Power Dissipation Derate Above 50°C (Note 1) @ $T_A = 50^\circ\text{C}$	P_d	1.0 8.0	W mW/ $^\circ\text{C}$
Typical Thermal Resistance - Junction to Terminal (Note 1)	$R_{\theta JT}$	30	$^\circ\text{C}/\text{W}$
Typical Thermal Resistance - Junction to Ambient (Note 1)	$R_{\theta JA}$	125	$^\circ\text{C}/\text{W}$
Operating and Storage Temperature Range	T_j, T_{STG}	-65 to +150	$^\circ\text{C}$

- Notes: 1. Device mounted on FR-4 PCB, 1 inch x 0.85 inch x 0.062 inch; pad layout as shown on Diodes Inc. suggested pad layout document AP02001, which can be found on our website at <http://www.diodes.com/datasheets/ap02001.pdf>.
2. RoHS revision 13.2.2003. Glass and High Temperature Solder Exemptions Applied, see *EU Directive Annex Notes 5 and 7*.

Electrical Characteristics @T_A = 25°C unless otherwise noted

Type Number (Note 4)	Marking Code	Zener Voltage Range (Note 3)			Test Current	Maximum Zener Impedance			Maximum Reverse Current		I _{ZM} Max (Note 1)
		V _Z @ I _{ZT}				I _{ZT}	Z _{ZT} @ I _{ZT}	Z _{ZK} @ I _{ZK}		I _R @ V _R	
		Nom (V)	Min (V)	Max (V)	mA	Ω	Ω	mA	μA	V	mA
SMAZ5V1	ZHK	5.1	4.84	5.40	100	5.0	500	1.0	2.5	1.0	196
SMAZ5V6	ZHL	5.60	5.32	5.88	100	2.0	250	2.0	5.0	2.0	179
SMAZ6V2	ZHN	6.20	5.89	6.51	100	2.0	200	2.0	5.0	3.0	161
SMAZ6V8	ZHO	6.80	6.46	7.14	100	2.0	200	1.0	5.0	4.0	147
SMAZ7V5	ZHQ	7.50	7.13	7.88	100	2.0	450	1.0	5.0	5.0	133
SMAZ8V2	ZHR	8.20	7.79	8.61	100	2.0	200	1.0	5.0	6.0	122
SMAZ9V1	ZHT	9.10	8.65	9.56	50	4.0	200	1.0	5.0	7.0	110
SMAZ10	ZHU	10.00	9.50	10.50	50	4.0	200	1.0	1.0	7.6	100
SMAZ12	ZHW	12.00	11.40	12.60	50	7.0	150	1.0	1.0	9.1	83
SMAZ15	ZHZ	15.00	14.25	15.75	50	10	150	1.0	1.0	11.4	67
SMAZ16	ZJA	16.00	15.20	16.80	25	15	150	1.0	0.5	12.2	63
SMAZ18	ZJF	18.00	17.10	18.90	25	15	150	1.0	0.5	13.7	56
SMAZ20	ZJG	20.00	19.00	21.00	25	15	180	1.0	0.5	15.2	50
SMAZ22	ZJK	22.00	20.90	23.10	25	15	180	1.0	0.5	16.7	45
SMAZ24	ZJL	24.00	22.80	25.20	25	15	180	1.0	0.5	18.2	42
SMAZ27	ZJN	27.00	25.65	28.35	25	15	200	1.0	0.5	20.5	37
SMAZ30	ZJQ	30.00	28.50	31.50	25	15	250	1.0	0.5	22.8	33
SMAZ33	ZJR	33.00	31.35	34.65	25	15	300	1.0	0.5	25.1	30
SMAZ36	ZJS	36.00	34.20	37.80	10	40	350	1.0	0.5	27.4	28
SMAZ39	ZJT	39.00	37.05	40.95	10	40	450	1.0	0.5	29.6	26

Ordering Information (Note 4)

Device*	Packaging	Shipping
SMAZx-13-F	SMA	5000/Tape & Reel

- Notes:
1. Device mounted on FR-4 PCB, 1 inch x 0.85 inch x 0.062 inch; pad layout as shown on Diodes Inc. suggested pad layout document AP02001, which can be found on our website at <http://www.diodes.com/datasheets/ap02001.pdf>.
 3. Short duration test pulse used to minimize self-heating effect.
 4. For Packaging Details, go to our website at <http://www.diodes.com/datasheets/ap02007.pdf>.

*x = Device Voltage, e.g., SMAZ5V1-13-F.

Marking Information

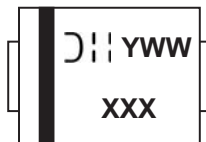

XXX = Product type marking code, ex. ZHK = SMAZ5V1
 ⤴ = Manufacturers' code marking
 YWW = Date code marking
 Y = Last digit of year ex: 2 for 2002
 WW = Week code 01 to 52

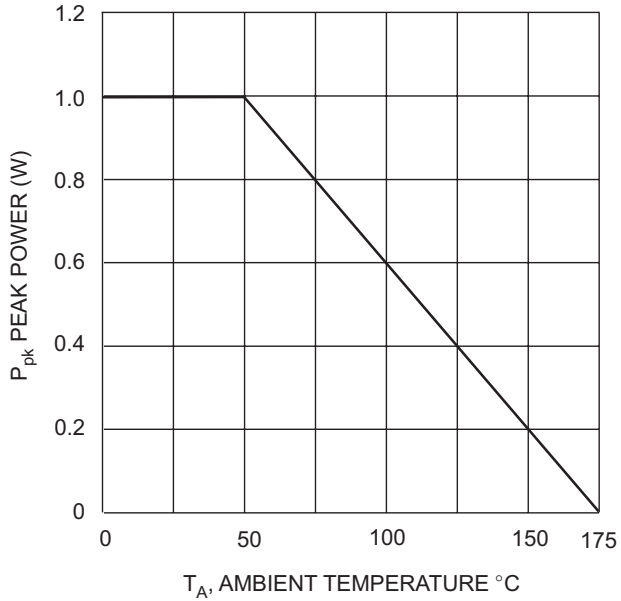

Fig. 1 Power Dissipation vs Ambient Temperature

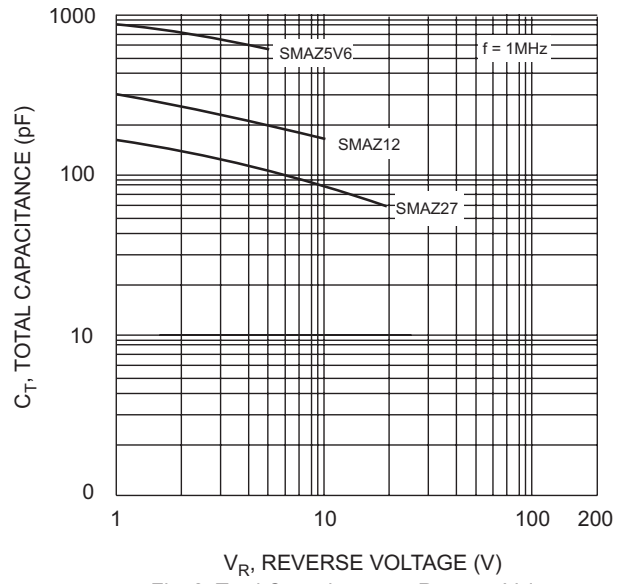

Fig. 2 Total Capacitance vs Reverse Voltage

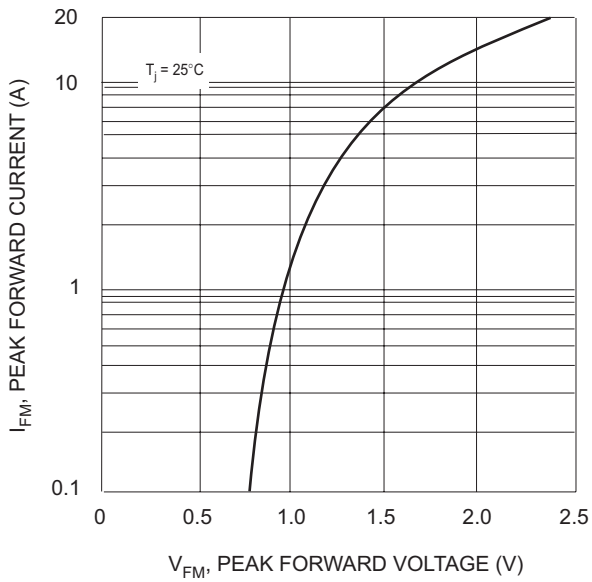

Fig. 3 Peak Forward Current vs Peak Forward Voltage

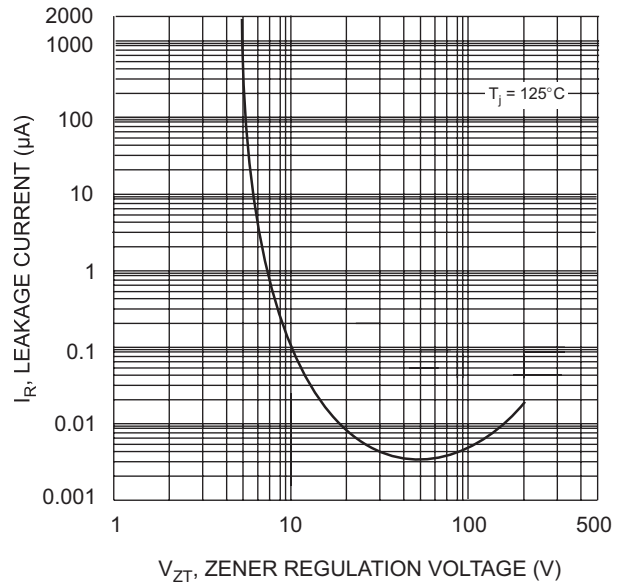

Fig. 4 Leakage Current vs Regulation Voltage

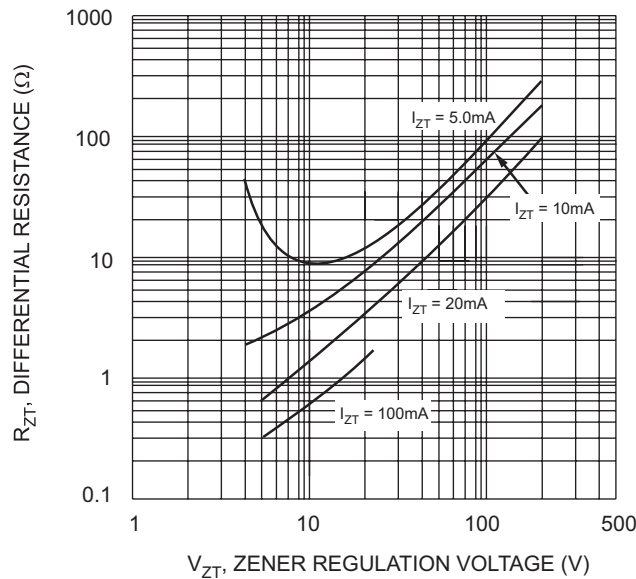

Fig. 5 Differential Resistance vs Regulation Voltage

IMPORTANT NOTICE

Diodes Incorporated and its subsidiaries reserve the right to make modifications, enhancements, improvements, corrections or other changes without further notice to any product herein. Diodes Incorporated does not assume any liability arising out of the application or use of any product described herein; neither does it convey any license under its patent rights, nor the rights of others. The user of products in such applications shall assume all risks of such use and will agree to hold Diodes Incorporated and all the companies whose products are represented on our website, harmless against all damages.

LIFE SUPPORT

Diodes Incorporated products are not authorized for use as critical components in life support devices or systems without the expressed written approval of the President of Diodes Incorporated.