

## 3-Volt Nanopower TMR Digital Switches

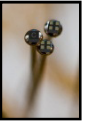

### Functional Diagram

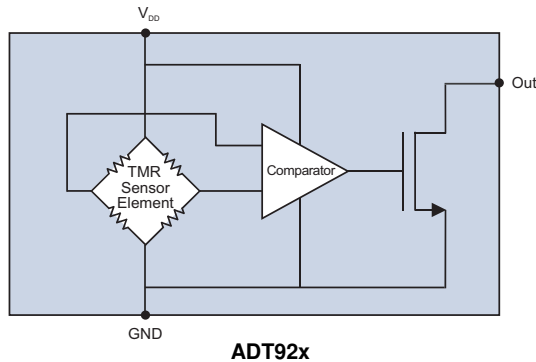

### Features

- 2.4 to 4.2 V operation for lithium or lithium-ion power
- 0.6 mA typical quiescent current at 3 V
- Continuous operation for immediate response
- Sensitive operate points, as low as 1.5 mT
- Ultraminiature 1.1 x 1.1 mm x 0.35 mm package

### Applications

- Implantable medical devices
- 3.3 volt microcontroller interfaces
- Proximity sensing
- Rechargeable sensor nodes
- Wearables
- Portable instruments

### Description

The ADT92x-14E sensors are digital switch devices based on novel magnetic tunnel junction technology that provides extremely low power consumption for 3.3 volt lithium or lithium-ion battery powered applications.

The output is configured as a magnetic “switch” where the output turns on when the magnetic field is applied, and turns off when the field is removed. The applied field can be either magnetic polarity, and the operate point is extremely stable over supply voltage and temperature. The output is current-sinking, and can sink up to 100 microamps.

The parts use NVE’s ultraminiature 1.1 mm x 1.1 mm x 0.35 mm ULLGA leadless packages. Die on tape are also available.

A wide range of magnetic operate points are available, and custom thresholds can be provided.

### Magnetic Response

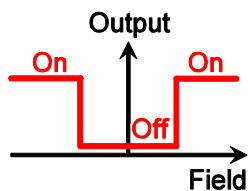

**Absolute Maximum Ratings**

Parameter	Min.	Max.	Units
Supply voltage		5.5	Volts
Output voltage		5.5	Volts
Output current		200	$\mu\text{A}$
Storage temperature	-65	135	$^{\circ}\text{C}$
Junction temperature		135	$^{\circ}\text{C}$
Applied magnetic field		Unlimited	

**Operating Specifications**

T <sub>min</sub> to T <sub>max</sub> ; 2.4 V < V <sub>DD</sub> < 4.2 V unless otherwise stated.						
Parameter	Symbol	Min.	Typ.	Max.	Units	Test Condition
Supply voltage	V <sub>DD</sub>	2.4	3.0	4.2	Volts	
Operating temperature	T <sub>MIN</sub> ; T <sub>MAX</sub>	-40		85	$^{\circ}\text{C}$	
Magnetic operate point <sup>1</sup>						
ADT925	H <sub>OP</sub>	1.1	1.5	1.7	mT	25 $^{\circ}\text{C}$ 2.4 V < V <sub>DD</sub> < 4.2 V
ADT924		1.8	2.2	2.5		
ADT923		2.6	3.2	3.5		
ADT922		3.6	4.5	6.4		
ADT925		0.5		2.3		-40 $^{\circ}\text{C}$ to 85 $^{\circ}\text{C}$ 2.4 V < V <sub>DD</sub> < 4.2 V
ADT924		1.2		3.2		
ADT923		2.0		4.2		
ADT922		3.0		7.0		
Magnetic release point	H <sub>REL</sub>	0.2		1	mT	
Hysteresis			0.3	0.8	mT	
Quiescent current	I <sub>DDQ</sub>		0.3	0.5	$\mu\text{A}$	V <sub>DD</sub> = 2.4 V
			0.6	1		V <sub>DD</sub> = 3 V
			1	1.6		V <sub>DD</sub> = 3.6 V
			1.5	2		V <sub>DD</sub> = 4.2 V
Output drive current	I <sub>OL-ON</sub>	100			$\mu\text{A}$	
Output low voltage	V <sub>OL</sub>		0.05	0.2	V	V <sub>DD</sub> = 3.6 V; I <sub>OL-ON</sub> = 100 $\mu\text{A}$
Output leakage current	I <sub>OL-OFF</sub>			2	nA	V <sub>DD</sub> = 3.6 V
Maximum switching frequency	f		20		kHz	V <sub>DD</sub> = 3 V; 3 dB reduction in sensitivity

**Notes:**

- 1 mT = 10 Oe in air.

**Operation**

**Direction of Magnetic Sensitivity**

As the field varies in intensity, the digital output will turn on and off. Unlike Hall effect or other sensors, the direction of sensitivity is in the plane of the package. The diagrams below show two permanent magnet orientations that will activate the sensor in the direction of sensitivity:

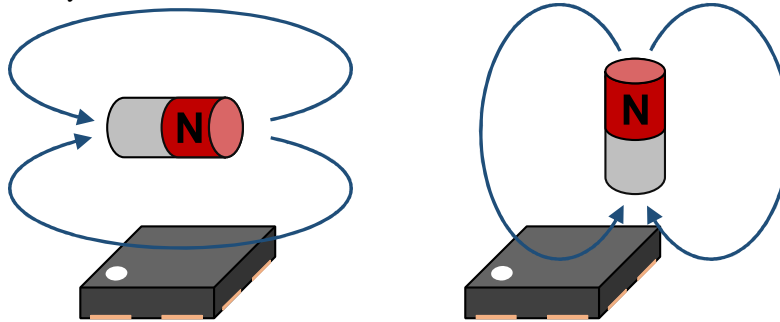

**Figure 1. ADT92x sensor direction of magnetic sensitivity.**

ADT92x Sensors are “omnipolar,” meaning the outputs turn ON when a magnetic field of either magnetic polarity is applied.

**External Pull-Up Resistor**

The output is LOW when the sensor is activated. The output is open-drain should have an external pull-up resistor. For microcontroller interfaces, the microcontroller’s input pull-up resistors can be activated (note that with a 3.3-volt supply, the pull-up resistor should be a minimum of 33 kΩ for compatibility with the sensor’s 100 μA output current).

**Typical Operation**

Figure 2 shows typical ADT92x sensor orientation. The arrow on the circuit board shows the direction of magnetic sensitivity.

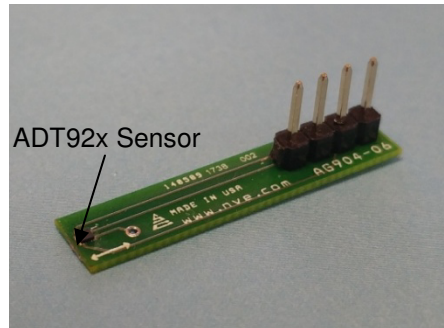

**Figure 2. Typical operation; the circuit board arrow shows direction of sensitivity.**

Typical magnetic operate and release distances for an inexpensive 4 mm diameter by 6 mm thick ceramic disk magnet are illustrated in the following table:

Part	Operate Point (typ.)	Operate Distance (typ.)	Release Distance (typ.)
ADT925-14E	1.5 mT	9 mm	12 mm
ADT924-14E	2.2 mT	8 mm	10 mm
ADT923-14E	3.2 mT	7 mm	9 mm
ADT922-14E	4.5 mT	6 mm	8 mm

Larger and stronger magnets allow farther operate and release distances. For more calculations, use our digital sensor switching versus distance Web application at: [www.nve.com/spec/calculators.php](http://www.nve.com/spec/calculators.php).

**Typical Performance**

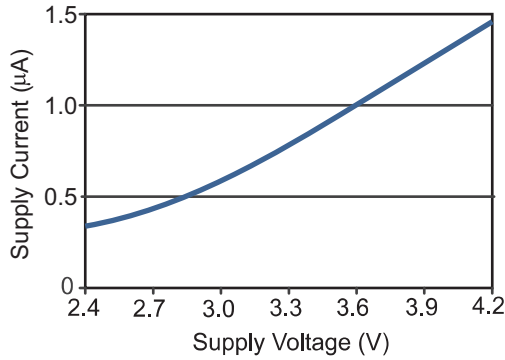

**Figure 3. Typical supply current vs. supply voltage (25°C)**

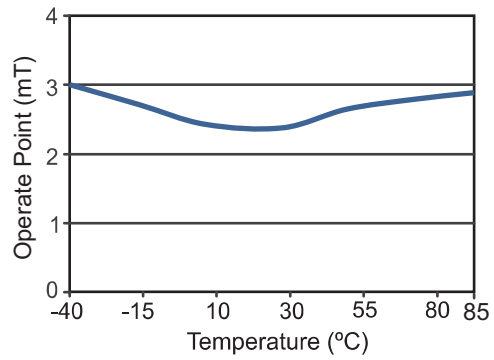

**Figure 4. Typical magnetic operate point vs. temperature (ADT923, V<sub>DD</sub> = 3 V)**

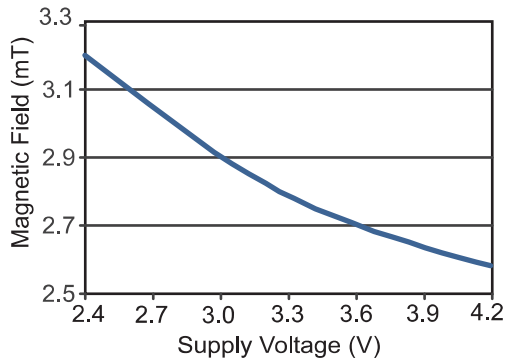

**Figure 5. Typical magnetic operate point vs. supply voltage (ADT923, 25°C)**

### Part Numbering

The following example shows ADT92x part numbering:

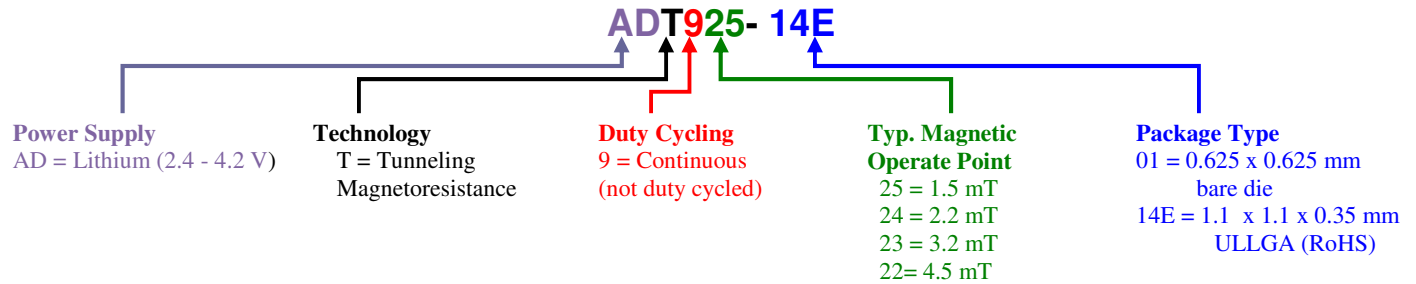

### Available Parts

Part Number	Operate Point (typ.)	Package	Marking
ADT925-01	1.5 mT	die	
ADT925-14E	1.5 mT	ULLGA	7
ADT924-01	2.2 mT	die	
ADT924-14E	2.2 mT	ULLGA	7
ADT923-01	3.2 mT	die	
ADT923-14E	3.2 mT	ULLGA	7
ADT922-01	4.5 mT	die	
ADT922-14E	4.5 mT	ULLGA	7

### Demonstration Board

The AG040T Demonstration Board is powered by a three-volt lithium coin cell (included). It has an ADT923-14E magnetic switch and an LED to show the sensor output. The sensor's low quiescent power allows the battery to last at least several years with occasional LED use. A miniature bar magnet is included so you can see for yourself how these remarkable sensors work. The board is just 1.57 by 0.25 inches (40 x 6 mm). The image is actual size:



### Bare Circuit Boards

NVE offers two bare circuit boards designed for easy connections to ULLGA sensors. Note that since these boards use very small sensors, they require reflow or hot-air soldering techniques. Images are actual size:



#### AG904-06: ULLGA General-Purpose PCB

1.2 x 0.25 inch (30 x 6 mm) PCB for connecting to 1.1 x 1.1 mm ULLGA4 sensors (-14E sensor suffix).



#### AG039-06: ULLGA Digital Sensor Demonstration Bare Board

A 1.57 x 0.25 inch PCB for demonstrating ADT92x or similar sensors (sensors sold separately). In addition to space for the sensor, the boards have locations for 0402-size pull-up resistors and bypass capacitors.

1.1 mm x 1.1 mm ULLGA Package (-14E suffix)

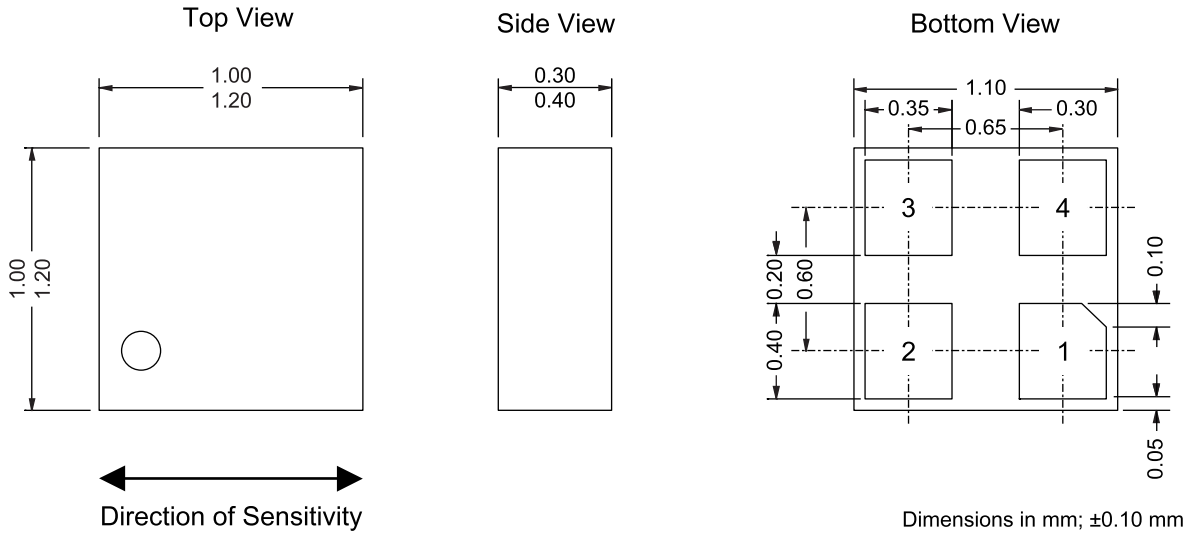

Dimensions in mm;  $\pm 0.10$  mm unless otherwise noted.

Pin 1	No Connect
Pin 2	$V_{DD}$
Pin 3	Out
Pin 4	Ground



Soldering profiles per JEDEC J-STD-020C, MSL 1.

*These products have been tested for electrostatic sensitivity to the limits stated in the specifications. However, NVE recommends that all integrated circuits be handled with appropriate care to avoid damage. Damage caused by inappropriate handling or storage could range from performance degradation to complete failure.*

**Revision History**

---

**SB-00-109B**

November 2019

**Change**

- Updates for new part types.

**SB-00-109A**

September 2019

**Change**

- Initial release.

### Datasheet Limitations

The information and data provided in datasheets shall define the specification of the product as agreed between NVE and its customer, unless NVE and customer have explicitly agreed otherwise in writing. All specifications are based on NVE test protocols. In no event however, shall an agreement be valid in which the NVE product is deemed to offer functions and qualities beyond those described in the datasheet.

### Limited Warranty and Liability

Information in this document is believed to be accurate and reliable. However, NVE does not give any representations or warranties, expressed or implied, as to the accuracy or completeness of such information and shall have no liability for the consequences of use of such information.

In no event shall NVE be liable for any indirect, incidental, punitive, special or consequential damages (including, without limitation, lost profits, lost savings, business interruption, costs related to the removal or replacement of any products or rework charges) whether or not such damages are based on tort (including negligence), warranty, breach of contract or any other legal theory.

### Right to Make Changes

NVE reserves the right to make changes to information published in this document including, without limitation, specifications and product descriptions at any time and without notice. This document supersedes and replaces all information supplied prior to its publication.

### Use in Life-Critical or Safety-Critical Applications

Unless NVE and a customer explicitly agree otherwise in writing, NVE products are not designed, authorized or warranted to be suitable for use in life support, life-critical or safety-critical devices or equipment. NVE accepts no liability for inclusion or use of NVE products in such applications and such inclusion or use is at the customer's own risk. Should the customer use NVE products for such application whether authorized by NVE or not, the customer shall indemnify and hold NVE harmless against all claims and damages.

### Applications

Applications described in this datasheet are illustrative only. NVE makes no representation or warranty that such applications will be suitable for the specified use without further testing or modification.

Customers are responsible for the design and operation of their applications and products using NVE products, and NVE accepts no liability for any assistance with applications or customer product design. It is customer's sole responsibility to determine whether the NVE product is suitable and fit for the customer's applications and products planned, as well as for the planned application and use of customer's third party customers. Customers should provide appropriate design and operating safeguards to minimize the risks associated with their applications and products.

NVE does not accept any liability related to any default, damage, costs or problem which is based on any weakness or default in the customer's applications or products, or the application or use by customer's third party customers. The customer is responsible for all necessary testing for the customer's applications and products using NVE products in order to avoid a default of the applications and the products or of the application or use by customer's third party customers. NVE accepts no liability in this respect.

### Limiting Values

Stress above one or more limiting values (as defined in the Absolute Maximum Ratings System of IEC 60134) will cause permanent damage to the device. Limiting values are stress ratings only and operation of the device at these or any other conditions above those given in the recommended operating conditions of the datasheet is not warranted. Constant or repeated exposure to limiting values will permanently and irreversibly affect the quality and reliability of the device.

### Terms and Conditions of Sale

In case an individual agreement is concluded only the terms and conditions of the respective agreement shall apply. NVE hereby expressly objects to applying the customer's general terms and conditions with regard to the purchase of NVE products by customer.

### No Offer to Sell or License

Nothing in this document may be interpreted or construed as an offer to sell products that is open for acceptance or the grant, conveyance or implication of any license under any copyrights, patents or other industrial or intellectual property rights.

### Export Control

This document as well as the items described herein may be subject to export control regulations. Export might require a prior authorization from national authorities.

### Automotive Qualified Products

Unless the datasheet expressly states that a specific NVE product is automotive qualified, the product is not suitable for automotive use. It is neither qualified nor tested in accordance with automotive testing or application requirements. NVE accepts no liability for inclusion or use of non-automotive qualified products in automotive equipment or applications.

In the event that customer uses the product for design-in and use in automotive applications to automotive specifications and standards, customer (a) shall use the product without NVE's warranty of the product for such automotive applications, use and specifications, and (b) whenever customer uses the product for automotive applications beyond NVE's specifications such use shall be solely at customer's own risk, and (c) customer fully indemnifies NVE for any liability, damages or failed product claims resulting from customer design and use of the product for automotive applications beyond NVE's standard warranty and NVE's product specifications.



An ISO 9001 Certified Company

NVE Corporation  
11409 Valley View Road  
Eden Prairie, MN 55344-3617 USA  
Telephone: (952) 829-9217

[www.nve.com](http://www.nve.com)

e-mail: [sensor-info@nve.com](mailto:sensor-info@nve.com)

©NVE Corporation

All rights are reserved. Reproduction in whole or in part is prohibited without the prior written consent of the copyright owner.

SB-00-109 Rev. B

*November 2019*